

EMERGENCY BRAKING OF FAST RUNNING LOADING / UNLOADING HOISTS

Prof. Dr.-Ing. Vöth St.

Faculty of Mechanical Engineering – Technische Fachhochschule Georg Agricola, Germany

voeth@tfh-bochum.de

Abstract: Cranes integrated in the logistic chain are vital elements to ensure safety and economic efficiency of transport. So safety is an essential factor for service of cranes in nuclear plants or metallurgical plants. For service of ship-to-shore-cranes the economic efficiency is an additional dominating aspect. A main assembly of every crane is the hoist. Following is shown, which internal forces occur in the components of a hoist with safety brake and are to be considered while dimensioning. In addition a concept for the design and the control of the braking system is shown in order to reduce the internal forces in hoist components of the rotational part of the drivetrain as couplings and gearing.

Keywords: CRANE, HOIST, SHIP-TO-SHORE CRANES, BRAKING SYSTEM

1. Starting point

Due to instationary service hoists are dynamically loaded structures. Especially for the case of emergency-off of safety oriented hoists with a safety brake on the rope drum disc high dynamic internal forces occur in the drivetrain [1, 2, 3]. Thus exists the risk of component failure, which can be observed in practical applications. The failure of a component, especially the hoist gearing, results in consequences relating safety and availability and is to be prevented. Thus a target oriented approach in planning of open winches is of special relevance.

2. Hoist structure

Generally hoists consist of a drive train, to the ends of which loads are applied: At one end the motor and the brake are located, at the other end the load is attached. At safety oriented hoists as in ship-to-shore-cranes (Fig. 1), in nuclear plant cranes and in cranes for transporting molten metal this looks a little bit different.



Fig. 1 Container Terminal Wilhelmshaven.

To cover a rupture of the drive train an additional safety brake is located on the board disc of the rope drum mostly. Thus a load can be applied in the middle of the drive train [1]. In comparison to the general hoist structure a modified dynamic behavior of the hoist is the consequence.

3. Braking process

It is task of brakes in hoists, if required, to stop the hoist within a certain time or without exceeding a certain further hoisting distance or lowering distance. Subsequent the hoist is to be hold in the reached position in the first instance.

During deceleration a braking torque must be delivered by the brakes. Amount and direction of the braking torque comply with the considered load case, which can be understood as the transition between two service conditions. The service conditions respectively the transitions between them can be visualized in the four-quadrant-diagram (Fig. 2).

The actions of motor and brakes during a braking procedure are not permanent. In fact a sequence of omitting and adding loads on

the drive train occurs. Especially the case of emergency-off is considered here with its special chronological scenario.

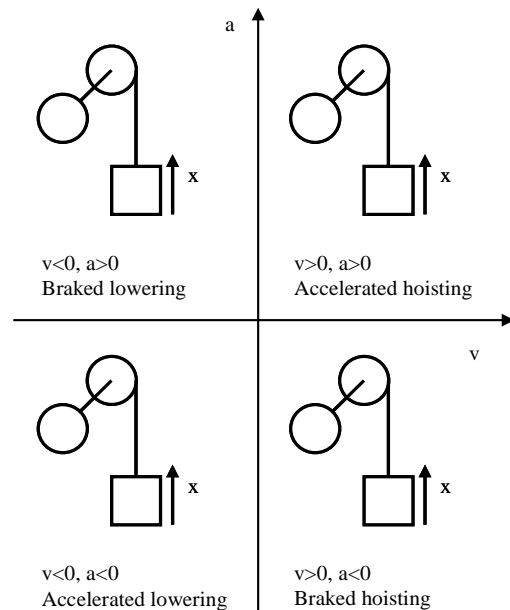

Fig. 2 Container Terminal Wilhelmshaven.

4. Reference system

For a closer look a partly redundant hoist with safety brakes is considered (Fig. 3).

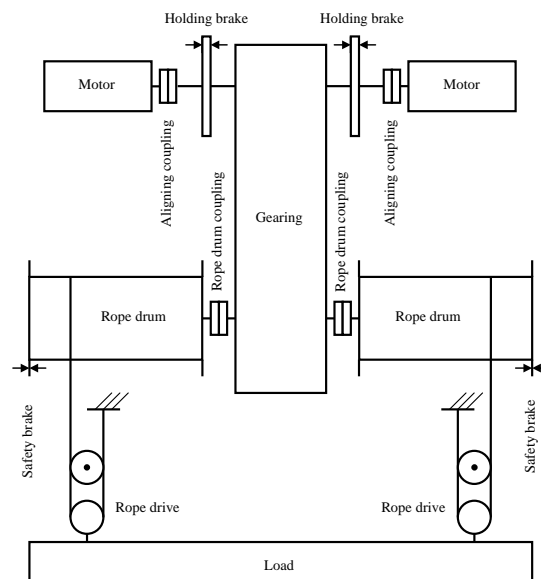

Fig. 3 Reference System.

Central element of the hoist is the gearing. The load is suspended by a load attachment device and a rope drive with 8/2 reeving. Both ropes are running onto a drum each, which are coupled with the gearing output shafts. On the board disc of each rope drum a safety brake is located. The hoist is driven by two motors which are connected to the gearing input shafts. On the motor shafts axis a service brake is located each.

The reference hoist is described by following data:

Motor speed	$n_1=1500\text{min}^{-1}$
Hoisting speed	$v_H=45\text{m/min}$
Mass motor shaft	$\theta_1=20\text{kgm}^2$
Mass rope drum shaft	$\theta_2=500\text{kgm}^2$
Mass load attachment device	$m_{LAM}=10\text{t}$
Mass SWL	$m_{SWL}=52\text{t}$
Radius rope drum	$r=0.5\text{m}$
Gearing ratio	$i_G=26.2$
Rope drive ratio	$i_S=4$
Service brake torque	$M_{BB}=5.8\text{kNm}$
Dead time service brake	$t_{totBB}=0.4\text{s}$
Safety brake torque	$M_{SB}=130\text{kNm}$
Dead time safety brake	$t_{totSB}=0.1\text{s}$
Gearing stiffness	$c=4e4\text{Nm/rad}$
Clearance drum coupling	$s=3^\circ$

5. Load cases

The hoist underlies in service different load cases, described by following parameters:

- Concerning the direction of movement holding, hoisting and lowering can be distinguished.
- Concerning the variation of speed constancy, acceleration and deceleration can be distinguished.
- Concerning the load suspended at the rope drive loads from dead load (load attachment device) to full load (load attachment device plus safe working load) may occur.

Concerning the internal forces are switching processes of interest. In doing so changes between following service conditions can occur:

- Suspended load
- Hoisting
- Lowering
- Service-stop
- Emergency-stop
- Emergency-off

Following load cases are considered, which will lead to high internal forces in the drivetrain by trend. Considered is the case of emergency-off for a hoist, which disposes of a fast acting safety brake and a slow acting service brake. Emergency-off means, that energy supply is cut off spontaneously and all components react accordingly. The motor torque is omitted and the brakes apply mechanically.

6. Kinetics

For the hoist represented as a rigid body model the behavior of load speed over time can be calculated. As a result for example the speed over time for different mechanical braking scenario out of hoisting/lowering the dead load are gained (Fig. 4).

The rigid body approach does not consider elasticity and clearance in the hoist system. Accordingly it is of interest to investigate the influence of these properties. Therefore the rigid body model is expanded by adding the elasticity of the gearing and the clearance in the rope drum coupling.

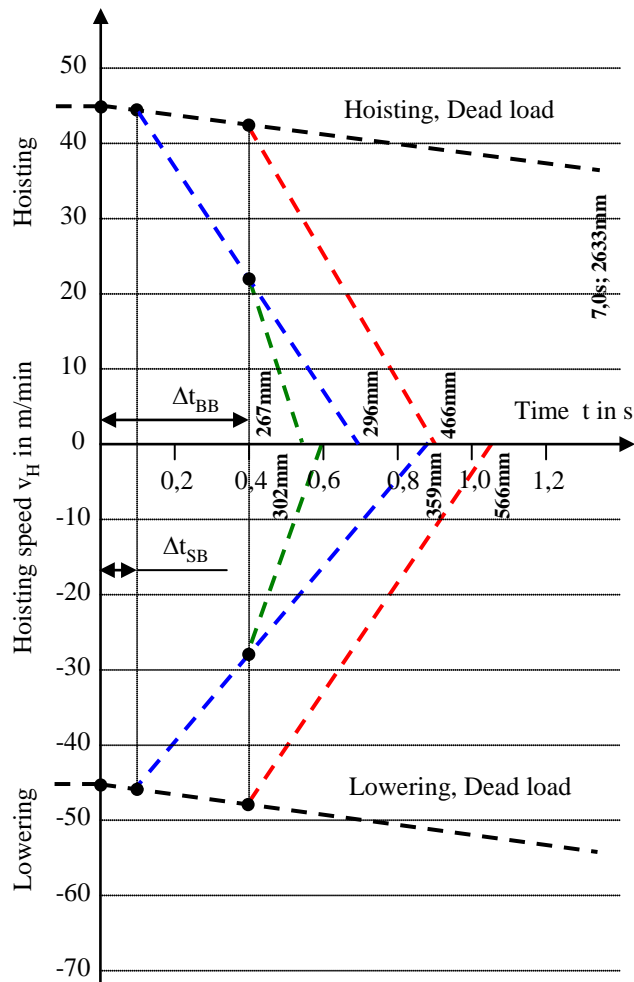

Fig. 4 Speed characteristics for braking dead load

7. Braking during hoisting

Examinations show the special relevance of the load case emergency-off out of hoisting the maximum load.

As observed the deceleration of the hoist occurs quickly. This is caused mainly due to the braking by the high load. Thus the deceleration process is finished as fast that the service brake (holding brake) with greater dead time in general is not or fairly not coming into action anymore. Firstly the torque for braking the motor mass is supplied by the load and the safety brake and transferred to the motor mass via the drive train.

With several assumptions the maximum relative gearing input torque for braking with the safety brake out of hoisting (+) or lowering (-) is calculated as

$$M_{G\ rel\ max} = \phi_5(MF(LF \pm BF_{SB}) - LF) + LF$$

Here the torque jump resulting out of the change of service condition according to the rigid body model is assessed with the dynamic factor for drives ϕ_5 corresponding EN 13001-2 [4].

The dynamic peak torques (Fig. 5) can occur, as far as they are supported by the static load, braking torque and inertia torque. Details regarding this are to be determined by an elasto-kinetic analysis. It is obvious for the considered load case that internal forces resulting in the drive train are a multiple of the static holding torque.

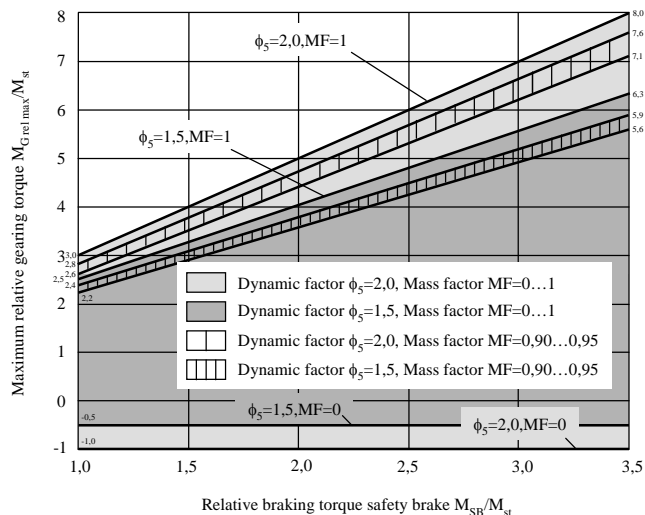

Fig. 5 Maximum relative gearing torque

8. Braking during lowering

Analyses show that especially the load case of emergency-off out of lowering the dead load is of interest.

Emergency-off immediately initiates switch-off of the motor and activation of the safety brake. For the mentioned data a maximum relative gearing input torque of $M_{G,rel,max} = 8.9$ is calculated (Fig. 6). That means the gearing torque is factor 8.9 higher than the maximum static loading of the drive train.

During lowering the hoist is driven by the load, which is hold in steady state condition by the motor. When the safety brake gets into action, the stoppage is executed very fast for this case as well. On one hand this is caused by the low load level, dead load. Assuming clearances in the drive train (in gearing and/or couplings) it is expected furthermore, that a flank change will occur. During this the motor side masses and the braked load side are uncoupled. Respectively the motor side masses need not to be decelerated.

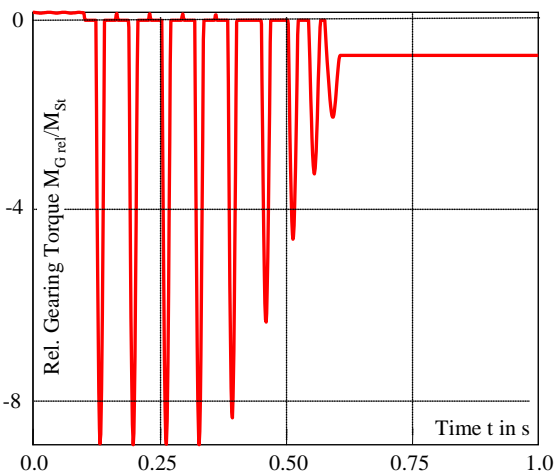

Fig. 6 Gearing torque according to elasto-kinetic hoist model

At an appropriate constellation the load side will stand still before running through the clearance is finished. In this case after running through the clearance a shock will occur. The motor side pitches on the standing load side. Toothed wheels and bearings in the gearing are loaded significantly by this shock. A special shock load may occur to the bearings of helical gears. In this case the shock is led in

axial direction of the shafts and with it on the roller bearing acting as fixed bearing.

9. Gearing loading

From the calculations maximum internal gearing torques much higher than according to static or rigid body approaches can be derived. Especially in the gearing such shock-like internal loads appear after running through clearances in relation with Hertzian contacts (toothing, roller bearings). To ensure safety such maximum internal loads must be covered statically. To ensure durability such maximum internal loads should not lead to pre-damages, which would lead to fatigue under further service loading.

10. „Intelligent“ braking

As measure to reduce peak values and amplitudes of the internal loads is considered: Synchronous and balanced action of all brakes participating in the braking process, here the service brake and the safety brake. This leads to a direct participation of the service brake in the braking process. This ideally results in a switching scenario with dead times of the service brake and the safety brake of $\Delta t_{BB} = \Delta t_{SB} = 0s$. Requirement is a holding of the motor torque until both brakes get into action.

Remains the question with which amount of torque the safety brake and the service brake should act. Favourable would be braking in a way that the quasi static internal torque before braking is still present during braking. Assuming these requirements given for the structure of the reference hoist following braking factors for the safety brake and the service brake for the braking out of hoisting (-) or lowering (+) are calculated:

$$BF_{BB} = \mp \left(LF + MF \frac{\theta_{ges}^*}{M_{st}^*} \frac{\Delta \omega}{\Delta t} \right)$$

$$BF_{SB} = \mp (1 - MF) \frac{\theta_{ges}^*}{M_{st}^*} \frac{\Delta \omega}{\Delta t}$$

For the reference hoist the brake factors and their sums are calculated as shown for braking out of hoisting (Fig. 7) and out of lowering (Fig. 8).

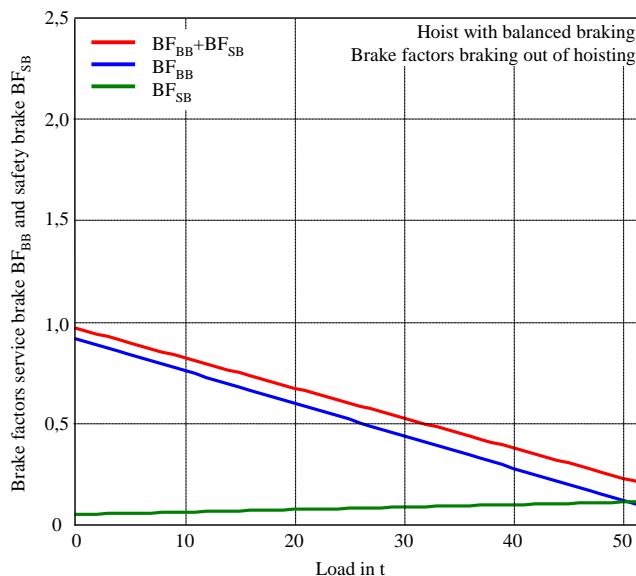

Fig. 7 Braking factors for braking out of hoisting

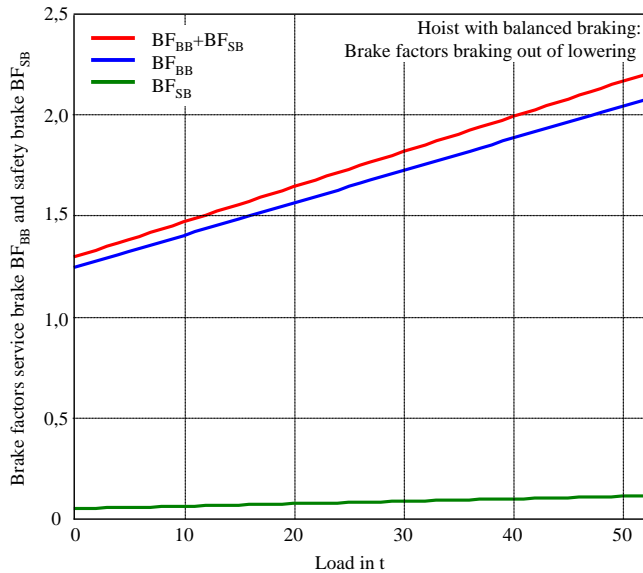

Fig. 8 Braking factors for braking out of lowering

For braking out of hoisting the safety brake has to be applied to a little account only ($BF_{SB}=5\%-12\%$). The service brake has to deliver a significant torque under partial load. With increasing loads up to full load the braking torque of the service brake is decreasing continuously ($BF_{BB}=92\%-8\%$).

For braking out of lowering the safety brake has to deliver only a small torque ($BF_{SB}=5\%-12\%$). The service brake has to deliver a significant torque under partial load. With increasing loads up to full load the braking torque of the service brake is increasing continuously ($BF_{BB}=124\%-208\%$).

11. Conclusions

For the higher internal loads occurring especially due to emergency-off [3] the hoist may be not dimensioned reasonably and efficiently. Assuming a corresponding hoist concept this also applies for emergency-stop, a load case occurring more often. Accordingly measures have to be considered in order to reduce internal loads induced to the drive train. The internal loads in the drivetrain are reduced especially by "intelligent braking". Ideally the braking process is designed in a way, that during braking in the drivetrain between motor and safety brake the torque during static hoisting is present also. Hereby the maximum values as well as the amplitudes of the internal forces are reduced significantly. Suitable measures to be applied are:

- Reduction of clearances and increase of system elasticity. As result shocks can be reduced and absorbed, as well as internal loads are reduced in connection with system damping.
- Minimization of dynamic effects. Following EN 13001-2 [4] this may be realized by little clearance and a gradual implementation of the braking torque.
- Reduction of mass factor MF. By a small share of the motor mass in relation to the total mass of the drivetrain the torque put through the gearing is reduced.
- Minimization of brake factor BF_{SB} . A small braking torque of the safety brake generally leads to less braking action and reduced internal forces.
- Braking action synchronous to motor switch-off. Is the motor moment decreasing before braking action

takes place, the drivetrain is relieved slightly. The resulting internal forces can be prevented by synchronicity of the events.

- Synchronized application of safety brake and service brake. In order to prevent torques put through the drive train a synchronized application of both brakes is inevitable. As a result the collision of the non-braked massive drive side mass (motor) and the braked load side mass (rope drum) is prevented. Corresponding shocks in assemblies with clearances as gearing and rope drum coupling are reduced. In typical hoist structures the dead time of the safety brake is significantly lower than that of the service brake. An expansion of dead time of the safety brake in most cases cannot be accepted. Accordingly a suitable approach is to shorten the dead time of the service brake [5].
- Balanced braking torque of safety brake and service brake. For adjusting the torques in the drive train defined braking torques at safety brake and service brake are required. Advisable is the balancing of both braking torques according to the energies to be dissipated at the locations of brakes. These braking torques depend on the service condition and the suspended load. Brakes with controllable torques are applied ideally. For cranes they are not state of the art today. Instead of the step less adjustment of torques a stepped adjustment of braking torques may be considered. This is realized by a parallel arrangement of several smaller brakes at one braking location. Hereby an approximation of the ideal condition is achieved.

References

- [1] RWTÜV Schriftenreihe, Heft 8, Krane, Bemessung und Sicherheit, 1981
- [2] Vöth: Safety Systems for Container Cranes, 17th ITI-Symposium, Dresden, 2014
- [3] Schmeink: Dynamische Beanspruchung von Hubwerksgetrieben, Tagungsband 22. Internationale Kranfachtagung, Magdeburg, 2014
- [4] EN 13001-2: Crane safety, General design, Part 2: Load actions
- [5] Römer: Difference between dynamic and static coefficient of friction, Port Technology International, 56. Edition, Winter 2012, P. 49-51